

# Patent Prosecution Highway Pilot Programme between the Intellectual Property Office of Singapore and the Mexican Institute of Industrial Property of the United Mexican States

## 1. Background

- 1.1 To obtain patent protection for an invention in several countries usually requires the invention to be searched and examined in each of the countries. If the patent authorities in these countries were to share the results of their search and/or examination with each other, the opportunity for a patent office to make reference to earlier work done could have several potential benefits:
- (a) Reduced work – Reference to the earlier work done could reduce or even eliminate the need for subsequent search and examination work.
  - (b) Accelerated examination – The reduced work could generally lead to a faster examination of the patent application.
  - (c) Better search and examination – Other patent offices might have access to databases unavailable (e.g. specific technical databases, local databases, databases in other languages) to the examiner, therefore the opportunity to refer to these search and examination results could provide the examiner with information on and assessment of prior art that he or she would otherwise not have access to.

## 2. Patent Prosecution Highway Programme

- 2.1 The Patent Prosecution Highway (PPH) programme between the Intellectual Property Office of Singapore (IPOS) and the Mexican Institute of Industrial Property (IMPI) is one way for the two offices to share their search and examination results with each other.
- 2.2 Where IPOS is the Office of Earlier Examination (OEE) and the IPOS application contains claims that are determined to be allowable/patentable, the applicant may request accelerated examination at the IMPI for the corresponding application filed with the IMPI as the Office of Later Examination (OLE). The requirements and procedures for filing a request with the IMPI for participation in the PPH pilot programme are available from the IMPI website at: <http://www.impi.gob.mx/patentes/Paginas/ProgramaProcedimientoAceleradoPatentes.aspx>
- 2.3 Where the IMPI is the OEE and the IMPI application contains claims that are determined to be allowable/patentable<sup>1</sup>, the applicant may request accelerated examination of the corresponding application filed with IPOS as the OLE by furnishing certain information of the IPOS application as set out in the requirements and procedures below.

## 3. PPH Pilot Programme Commencement

- 3.1 The PPH pilot programme commenced on April 14, 2014 for a period of 2 years, ending on April 13, 2016. It is subsequently extended until 14 April 2020. Thereafter, the programme is further extended for another 3 years until 14 April 2023.

---

<sup>1</sup> Allowed claims from a utility model or a petty patent cannot be used to form the basis for requesting PPH in IPOS.

3.2 IPOS and the IMPI will evaluate the results of the pilot programme to determine whether and how the programme should be fully implemented. The Offices may also terminate the PPH pilot programme if the volume of participation exceeds manageable level, or for any other reason. Notice will be published if the PPH pilot programme will be terminated.

#### **4. Requirements for requesting accelerated examination of an IPOS patent application under the PPH**

4.1 Both the IPOS application for which acceleration is requested and the IMPI application(s) forming the basis of the PPH request shall have the same earliest date (whether this is a priority date or a filing date).

4.2 The IMPI application has at least one claim that is determined to be allowable/patentable by the IMPI.

4.3 All claims in the IPOS application must sufficiently correspond or be amended to sufficiently correspond to one or more of the claims found allowable/patentable by the IMPI. Claims will be considered to sufficiently correspond where, accounting for differences due to translations and claim format, the claims are of the same or similar scope, or the claims are narrower in scope. In this regard, a claim that is narrower in scope occurs when a claim in the IPOS application is amended to be further limited by an additional technical feature that is supported in the specification.

4.4 Examination has not begun on the IPOS application.

4.5 Diagrams depicting a list of scenarios in which a request for accelerated examination of the IPOS application under the PPH pilot programme can be made are found in Annex I.

#### **5. Procedures for requesting accelerated examination of an IPOS patent application under the PPH**

5.1 File duly completed Patents Form 11 (Request for Search and Examination Report) or Patents Form 12 (Request for Examination Report). These forms can be found at: <https://www.ip2.sg/RPS/WP/Default.aspx> (electronic versions for online filing) and <http://www.ipos.gov.sg/Services/FilingandRegistration/FormsandFees/Patents.aspx> (downloadable versions for paper filing).

5.2 The Patents Form 11 or Patents Form 12 must be accompanied by:

- (a) a copy of all office actions of the IMPI application being relied upon;
- (b) a copy of the allowable/patentable patent claims referred to in (a) above; and
- (c) a claims correspondence table showing the relatedness of the allowable/patentable claims referred to in (a) above to the claims in the current IPOS application. The format of the Claims Correspondence Table is found in Annex II.

5.3 The documents listed in 5.2 (a) will include the following national work products:

- (a) written opinion established by IMPI as the national Office or (ii) examination report and decision of grant established by IMPI as the national Office during the processing of a national application or

- (b) a Patent Cooperation Treaty (PCT) application that has entered the national phase before the IMPI.
- 5.4 For avoidance of doubt, a copy of the patent grant without the documents listed in 5.2 (a), (b) and (c) above will not qualify for the PPH.
- 5.6 The checkbox for “ASPEC/PPH” must be selected in the Patents Form 11 or Patents Form 12.
- 5.7 If the request for PPH is sought after the Patents Form 11 or Patents Form 12 is filed, the request together with any supporting documents must be made in writing to IPOS. An email must also be sent to IPOS at [pph@ipos.gov.sg](mailto:pph@ipos.gov.sg) on the same day the request is submitted to IPOS. The email must contain in its subject, the title "PPH acceleration requested".
- 5.8 Any subsequent correspondences with IPOS must also be marked with the phrase “PPH acceleration requested”.

## **6. Cited Documents**

A copy of each of the documents cited in the documents submitted under paragraph 5.2 (a) is not required at the time of filing the PPH request. IPOS may, however, require the applicant to furnish a copy of any document cited subsequently.

## **7. Translations**

- 7.1 The documents in paragraph 5.2 must be accompanied by an English translation if they are not originally in English, at the time of filing the PPH request.
- 7.2 The documents in paragraph 6 may be filed in their original language. However, IPOS may subsequently request for an English translation of a document or a part of a document if an English abstract of the cited document is not available.
- 7.3 If it is not possible for IPOS to understand the English translation of any document, IPOS can request the applicant to resubmit the English translation of that document.

## **8. PPH Request**

IPOS will treat a PPH request as a request for accelerated examination under the PPH pilot programme. Where the PPH request is granted, the IPOS application will be processed in an accelerated manner. In those instances where the PPH request does not meet all the requirements and procedures set forth above, the applicant will be notified and the defects in the request will be identified. The applicant will be given one opportunity to correct formal deficiencies identified in the request. If the request is not corrected, the application will be taken out of the PPH programme and the applicant will be notified.

## **9. Examination of IPOS patent application under the PPH pilot**

- 9.1 The IPOS application will be examined in accordance with the Singapore Patents Act (Cap. 221) and the Singapore Patents Rules. The legislations can be found at: <http://www.ipos.gov.sg/AboutIP/IPLegislation.aspx>
- 9.2 Applicants should seek professional advice on patent matters in Singapore, in particular, with reference to section 30 (Grant of patent) and section 69 (Restrictions on relief for infringement) of the Singapore Patents Act (Cap. 221).

## **10. Enquiries**

For enquiries relating to the Patent Prosecution Highway pilot programme, please send an email to [pph@ipos.gov.sg](mailto:pph@ipos.gov.sg) .

INTELLECTUAL PROPERTY OFFICE OF SINGAPORE  
DATE: 21 May 2020

**Annex I**

**Scenario (1a):** The IPOS application validly claims priority under section 17 of the Singapore Patents Act (Cap. 221) from the IMPI application being relied upon for the PPH request.

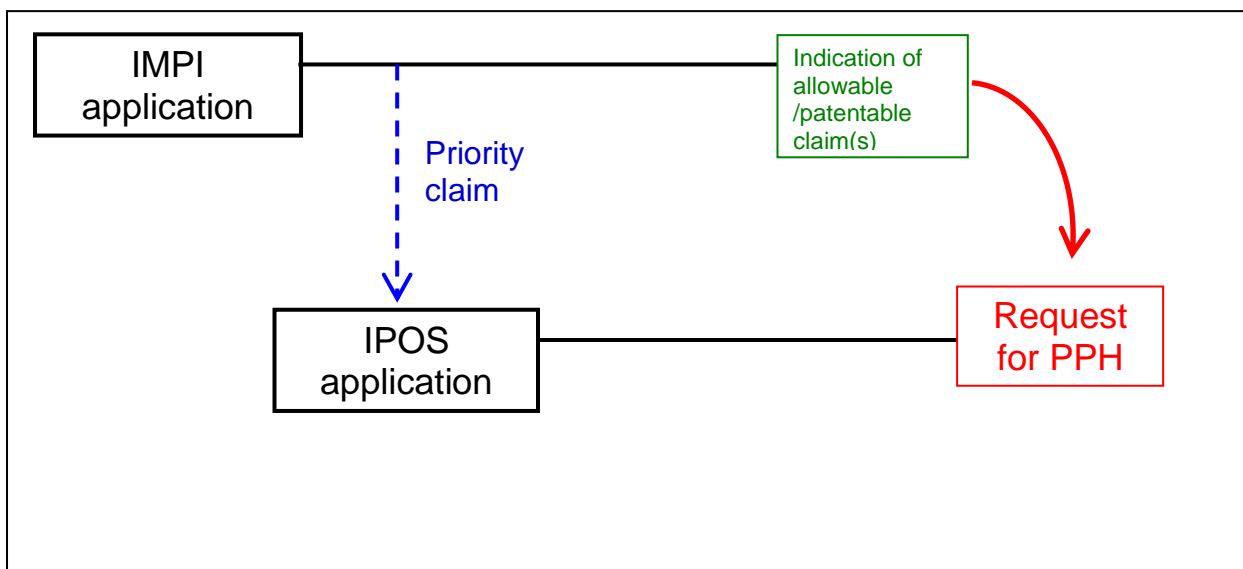

**Scenario (1b):** The request for PPH can also be made in the reverse of scenario (1a) where the IMPI application claims priority from the IPOS application.

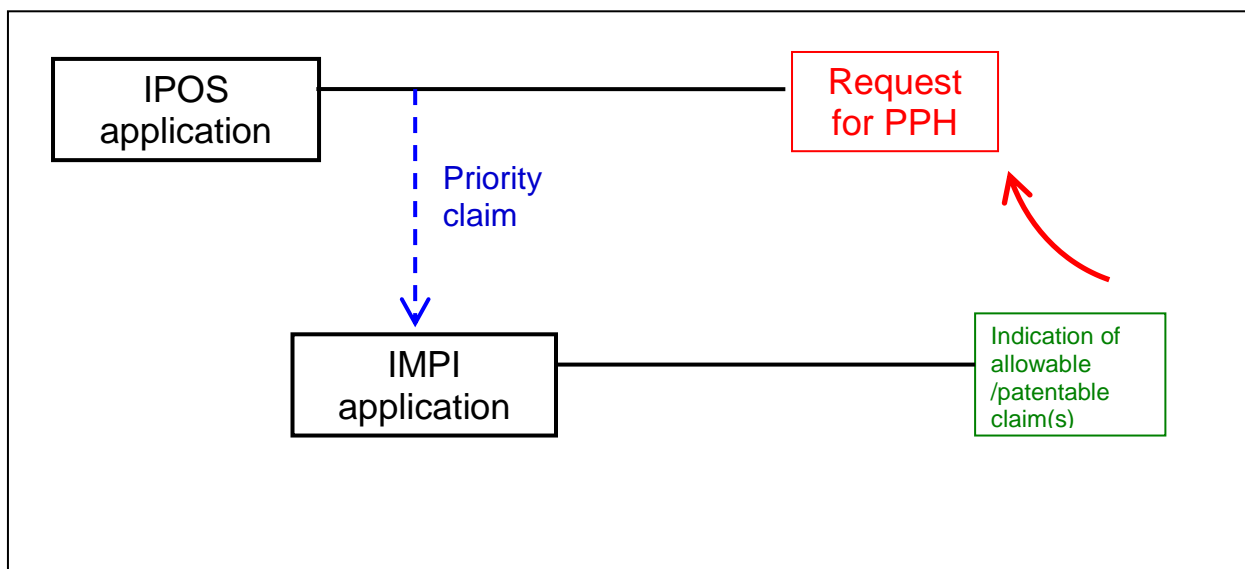

**Scenario (1c):** The request for PPH can also be made a variation of scenario (1a) where the IPOS application also claims priority from another IP office application.

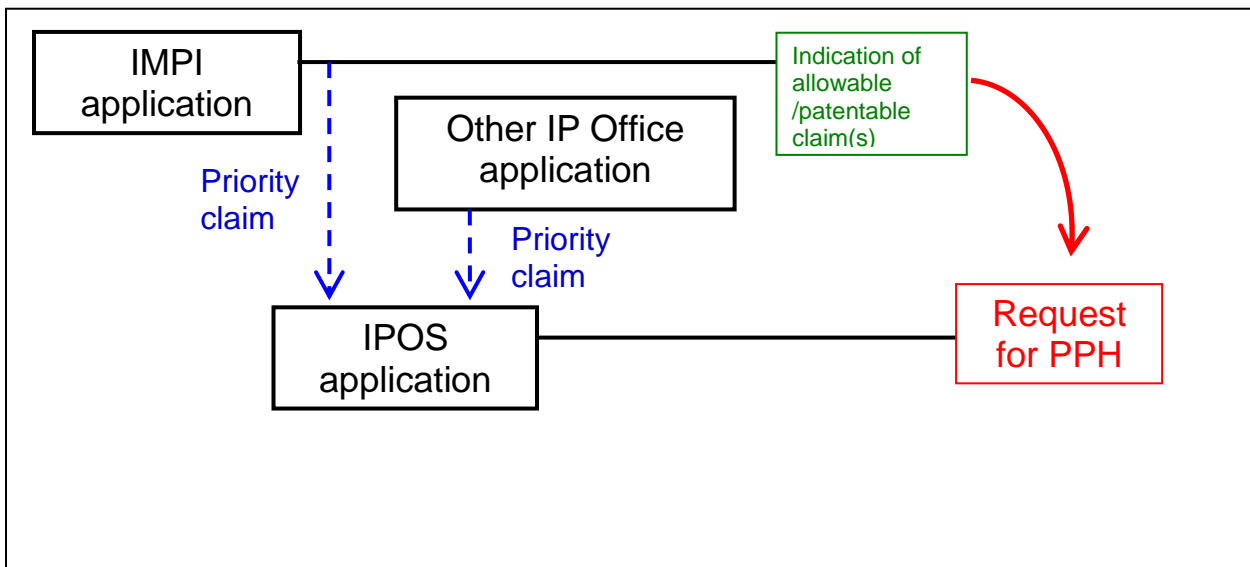

**Scenario (1d):** The request for PPH can also be made in the reverse of scenario (1c) where the IMPI application also claims priority from another IP office application.

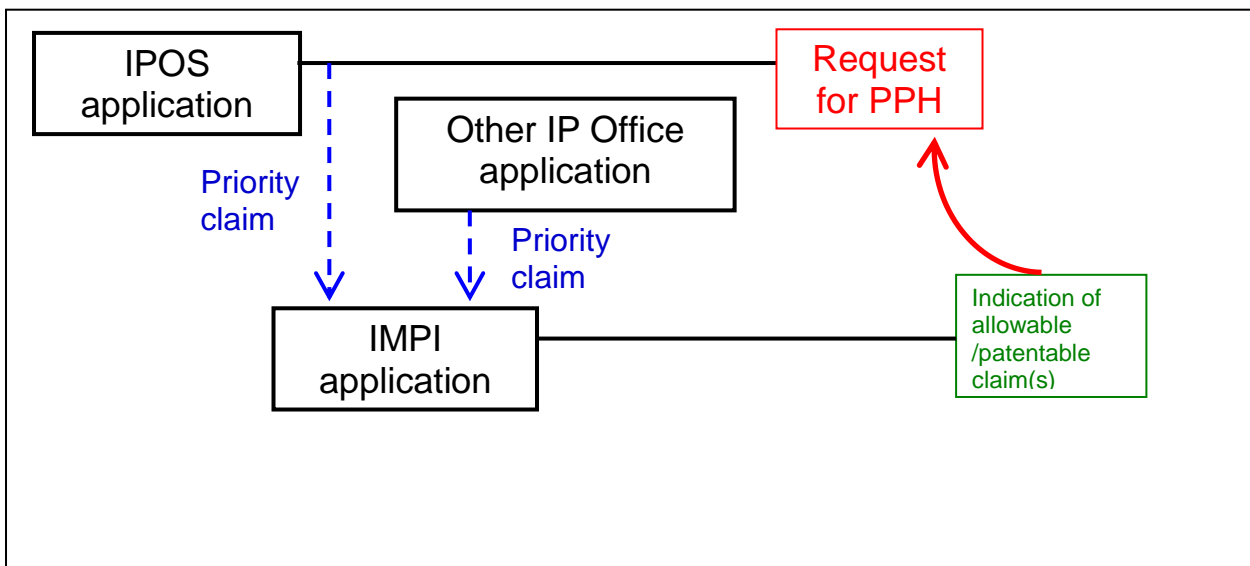

**Scenario (2a):** The IPOS application is a divisional application of the IMPI application referred to in (1) above, and said divisional application validly claims priority under section 17 of the Singapore Patents Act (Cap. 221) from the IMPI application being relied upon for the PPH request.

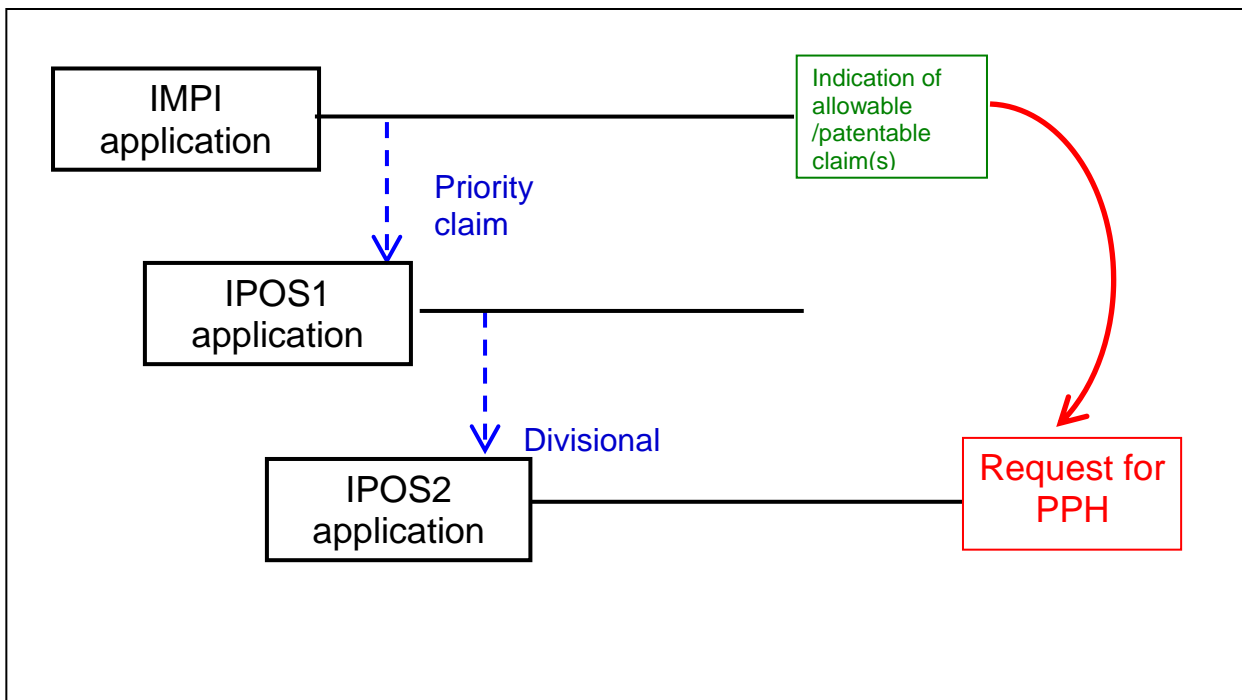

**Scenario (2b):** The request for PPH can also be made in the reverse of scenario (2a) where the IMPI application claims priority from the IPOS application.

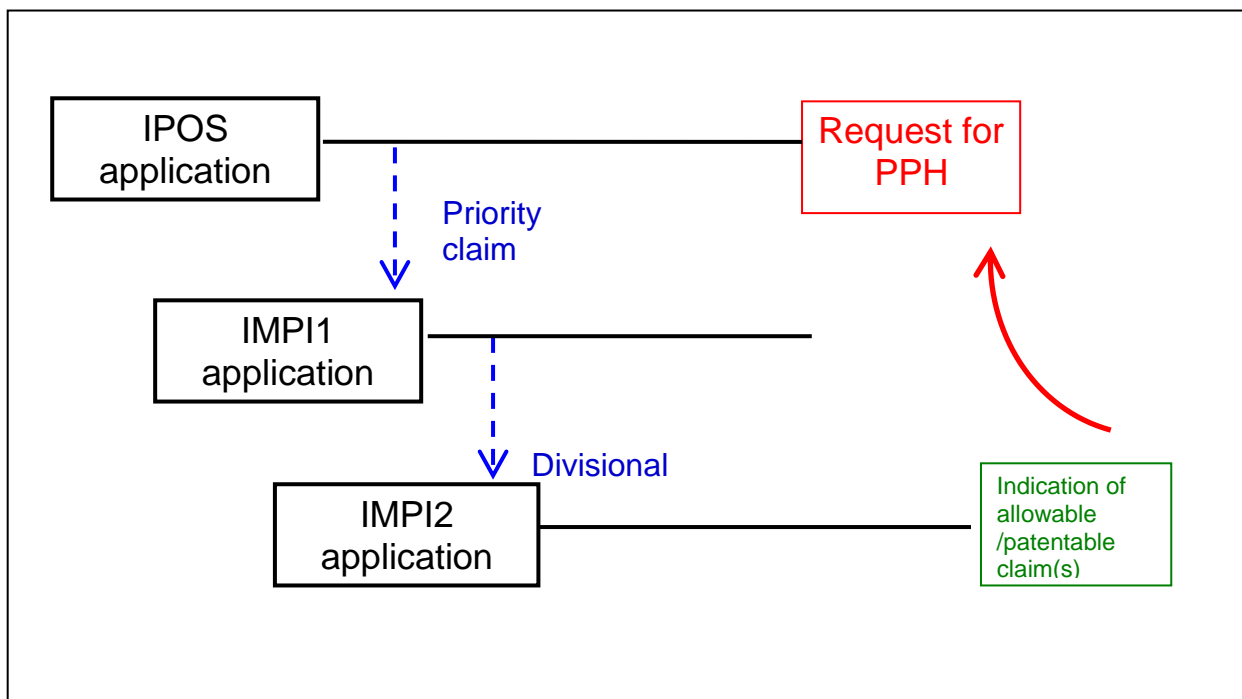

**Scenario (3a):** The IPOS application validly claims priority under section 17 of the Singapore Patents Act (Cap. 221) from the IMPI application (“IMPI1 application”), and the IMPI application being relied upon for the PPH request (“IMPI2 application”) also validly claims domestic priority from IMPI1 application.

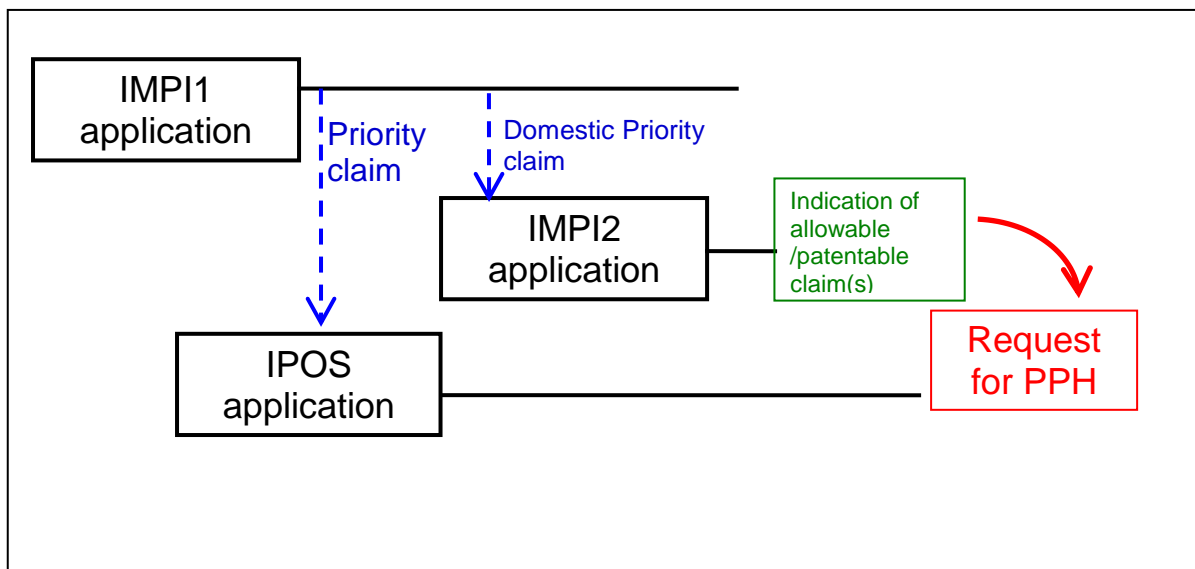

**Scenario (3b):** The request for PPH can also be made in the reverse of scenario (3a) where the IMPI application claims priority from the IPOS application.

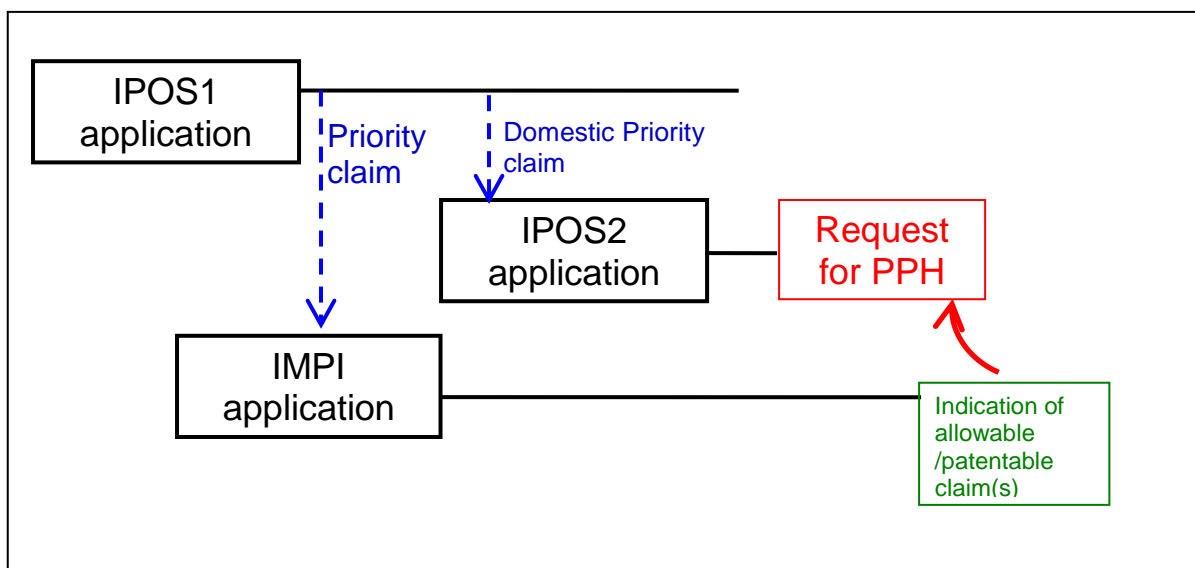



**Scenario (4a):** The IPOS application is a divisional application of the IPOS application referred to in (3) above, and said divisional application validly claims priority under section 17 of the Singapore Patents Act (Cap. 221) from the IMPI application (“IMPI1 application”), and the IMPI application being relied upon for the PPH request (“IMPI2 application”) also validly claims domestic priority from IMPI1 application.

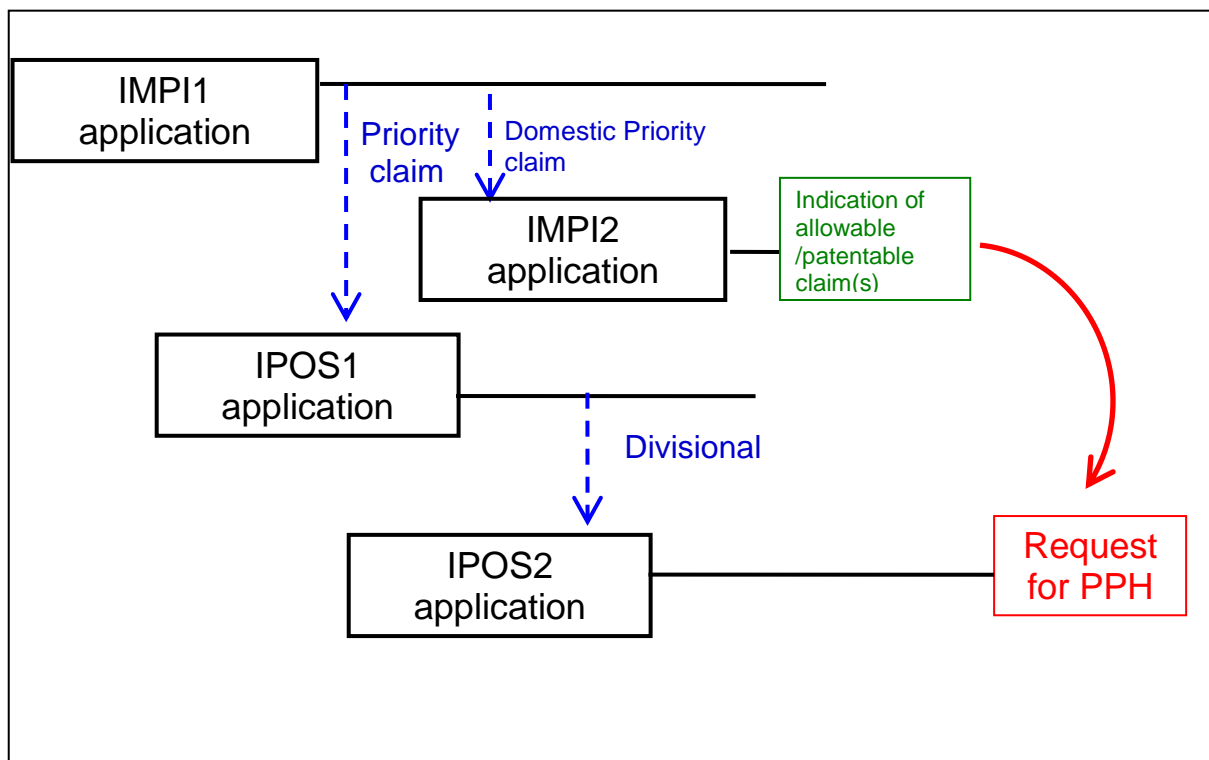

**Scenario (4b):** The request for PPH can also be made in the reverse of scenario (4a) where the IMPI application claims priority from the IPOS application.

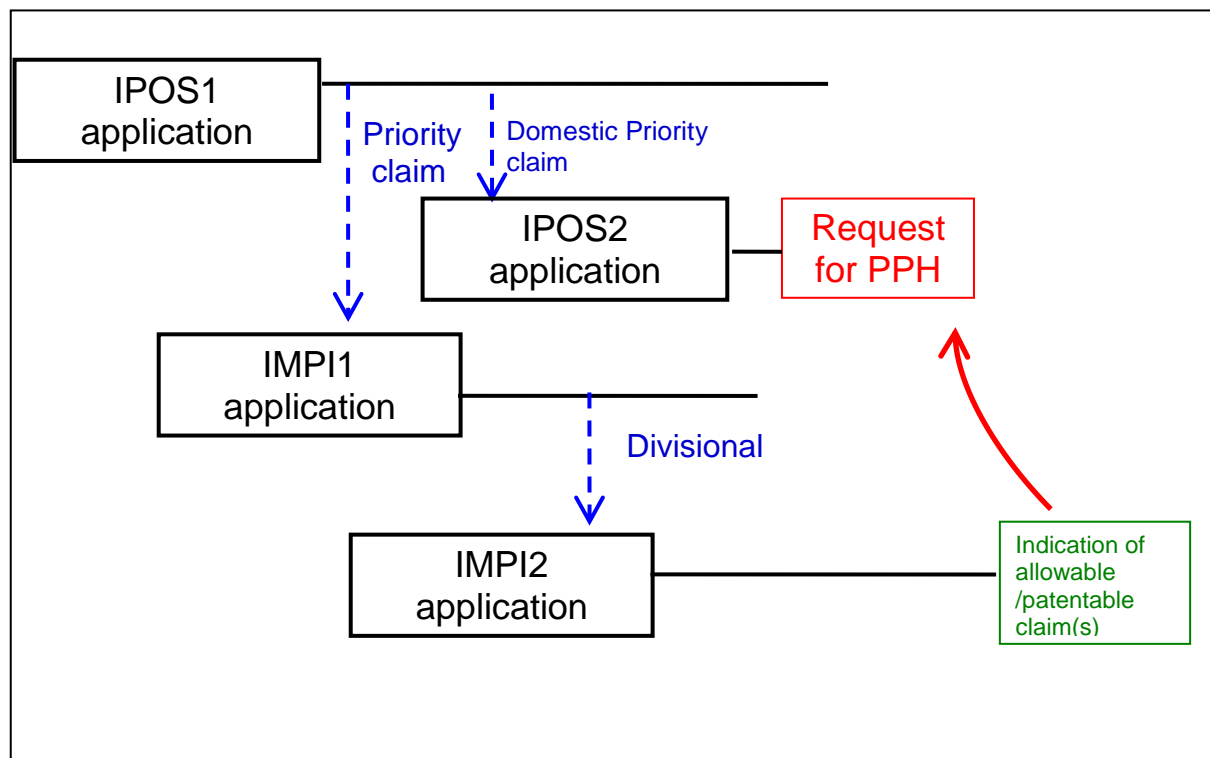

**Scenario (5a):** The IPOS application is a national phase entry of a PCT application (“IPOS NP application”), and the IPOS application validly claims priority under section 17 and section 87 of the Singapore Patents Act (Cap. 221) from the IMPI application. The IMPI application is being relied on for the PPH request.

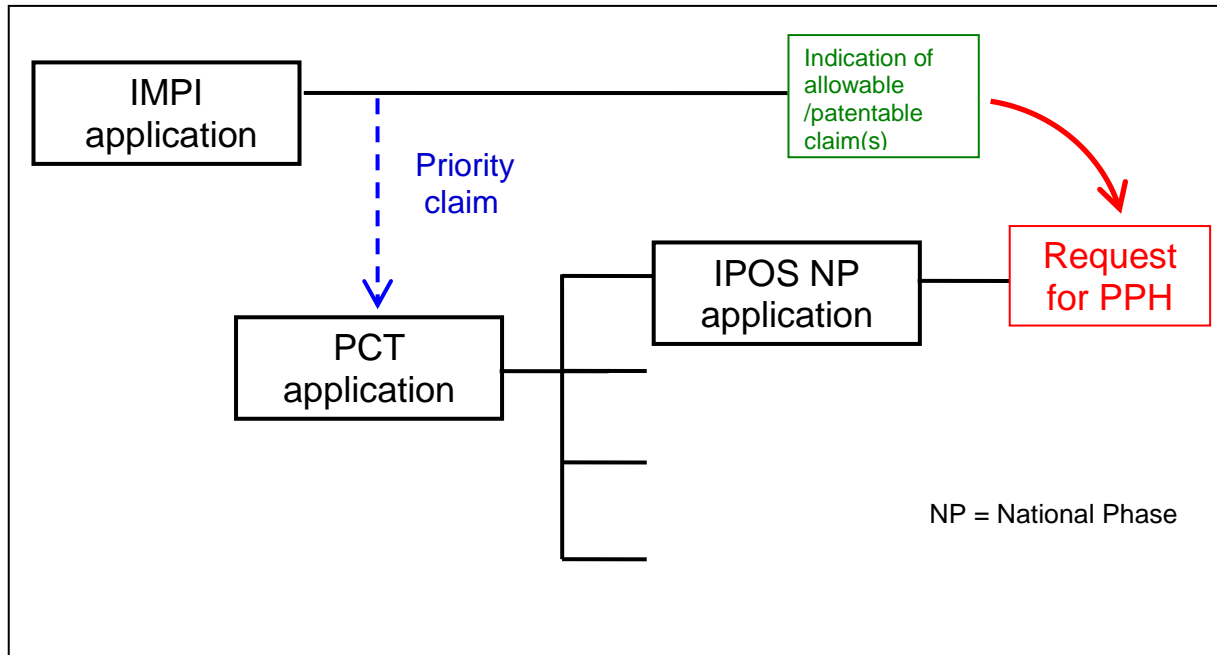

**Scenario (5b):** The request for PPH can also be made in the reverse of scenario (5a) where the IMPI application is a national phase entry of a PCT application which claims priority from the IPOS application.

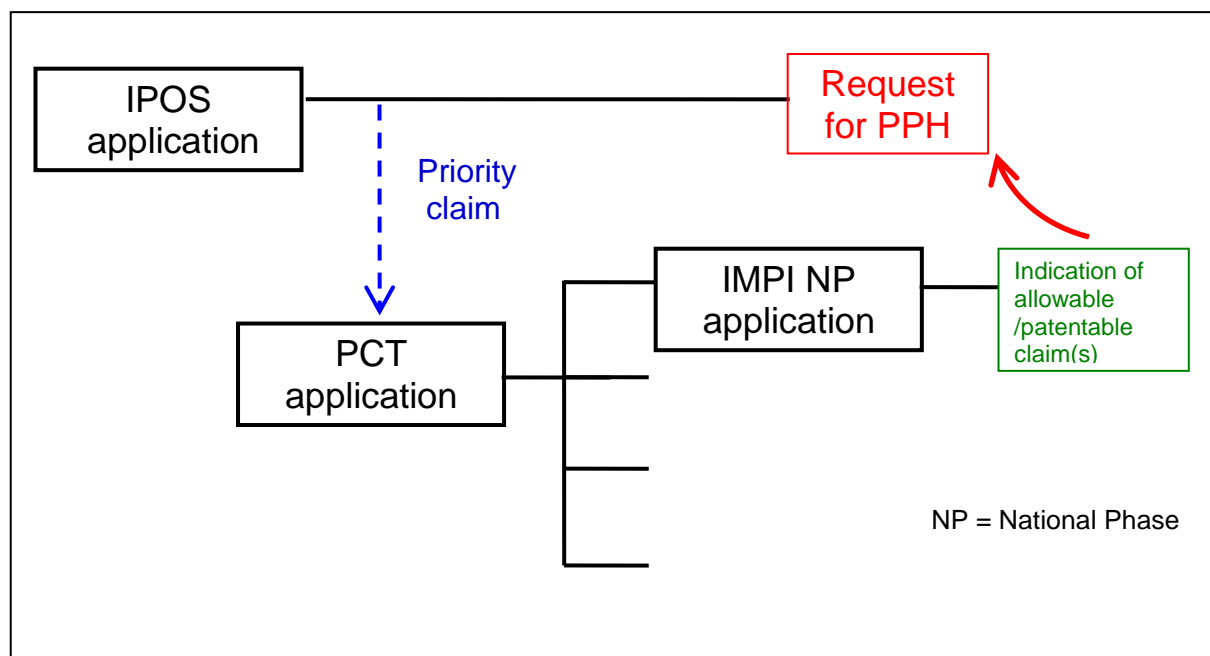

**Scenario (6a):** The IPOS application is a national phase entry of a PCT application (“IPOS NP application”), and the IPOS application validly claims priority under section 17 and section 87 of the Singapore Patents Act (Cap. 221) from the IMPI application (“IMPI1 application”). The IMPI application being relied upon for the PPH request (“IMPI2 NP application”) is a national phase entry of the same PCT application, and IMPI2 NP application validly claims priority from IMPI1 application.

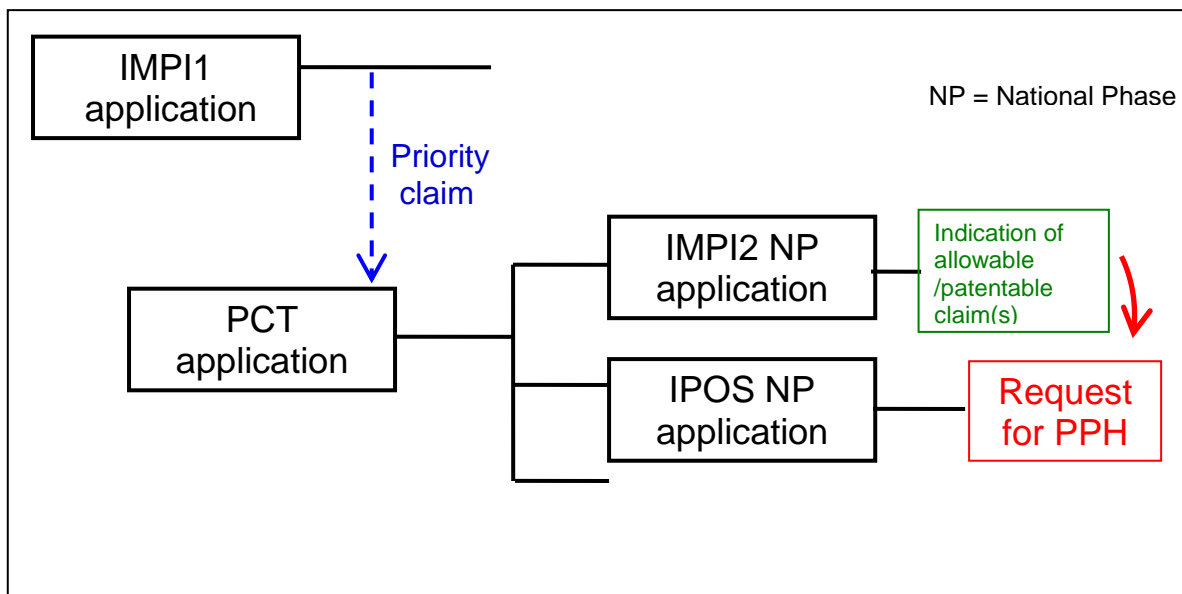

**Scenario (6b):** The request for PPH can also be made in the reverse of scenario (6a) where the IMPI application is a national phase entry of a PCT application and which claims priority from the IPOS1 application. The IPOS1 application can also be first filed in another office other than IPOS or the IMPI.

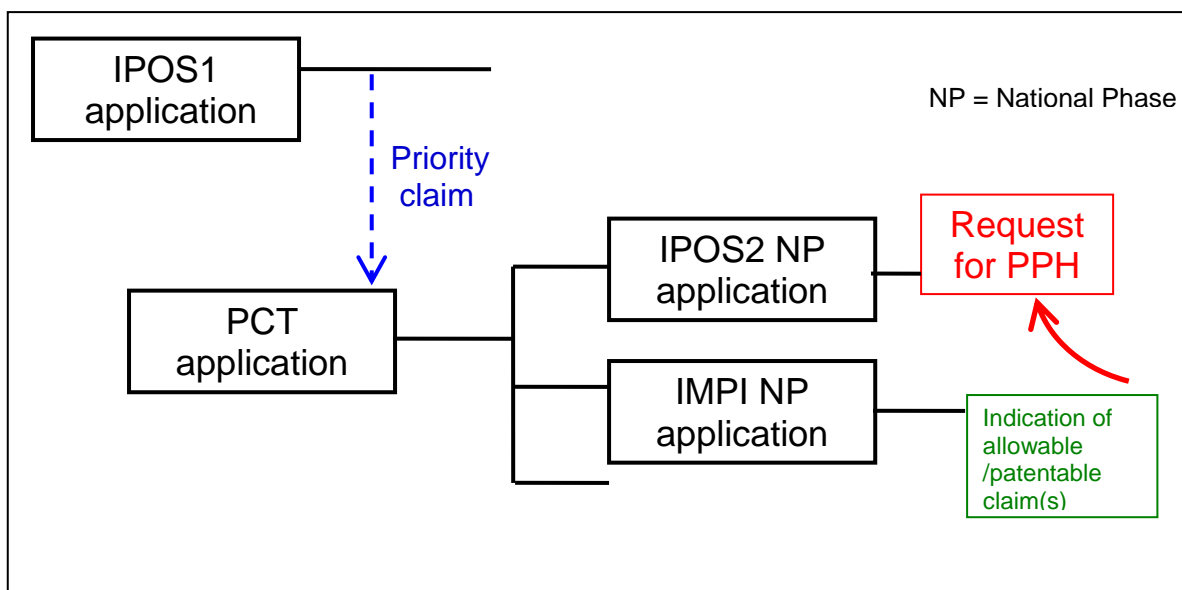

**Scenario (7):** There are two PCT applications, the second application validly claiming priority from the first application. The IPOS application (“IPOS NP application”) is a national phase entry of the second PCT application, and the IPOS NP application validly claims priority under section 17 and section 87 of the Singapore Patents Act (Cap. 221) from the first PCT application. The IMPI application (“IMPI NP application”) being relied upon for the PPH request is a national phase entry of the second PCT application, and the IMPI NP application validly claims priority from the first PCT application.

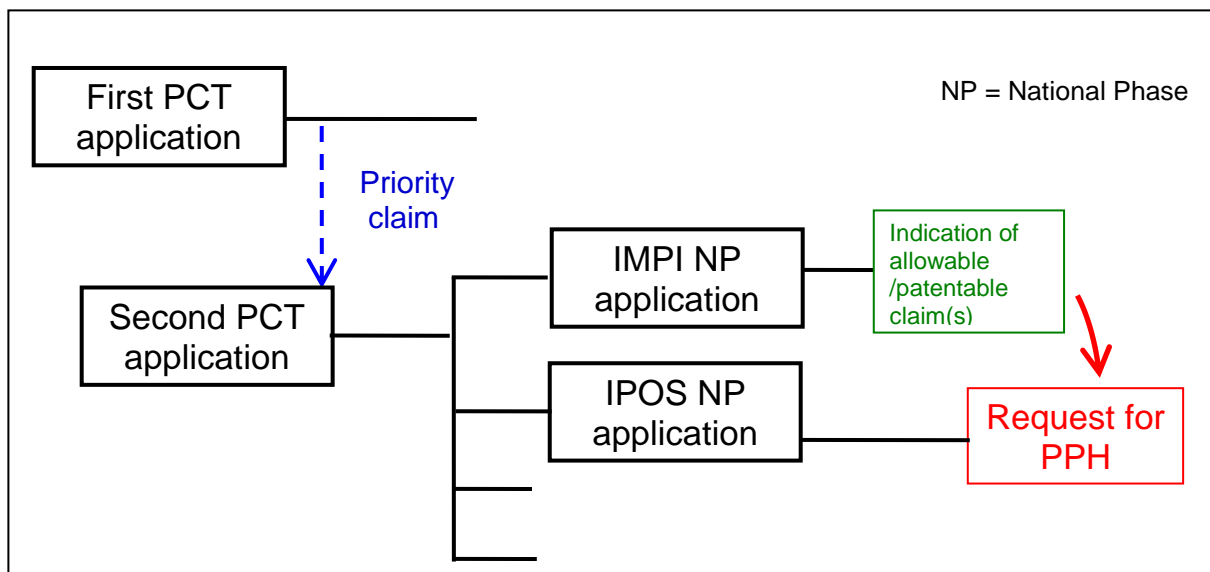

**Scenario (8):** There is a first application filed in an office other than the IPOS or the IMPI. The IPOS application validly claims priority under section 17 of the Singapore Patents Act (Cap. 221) from the first application. The IMPI application being relied upon for the PPH request also validly claims priority from the first application.

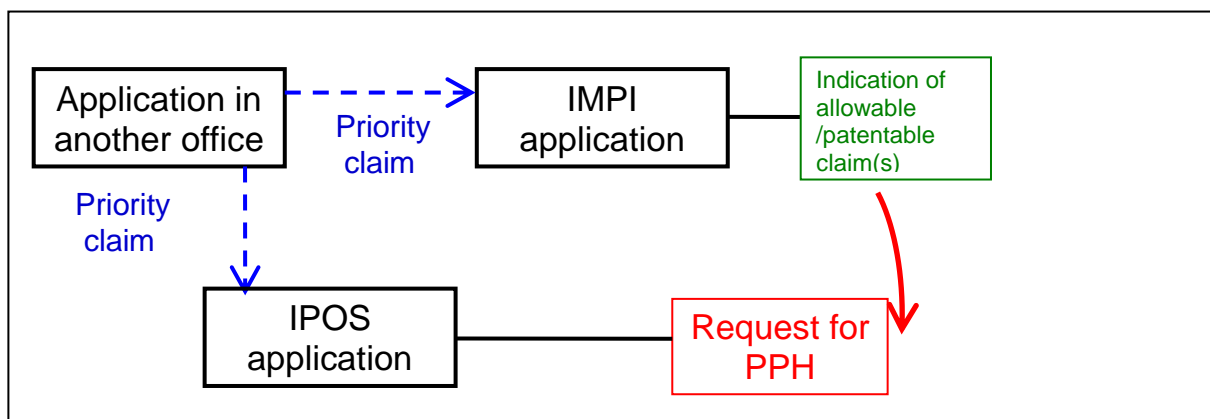

**Scenario (9):** The IPOS application (“IPOS NP application”) is a national phase entry of a PCT application, and the IPOS NP application validly claims priority under section 17 and section 87 of the Singapore Patents Act (Cap. 221) from an application filed in another office. The IMPI application being relied upon for the PPH request also validly claims priority from the application filed in another office.

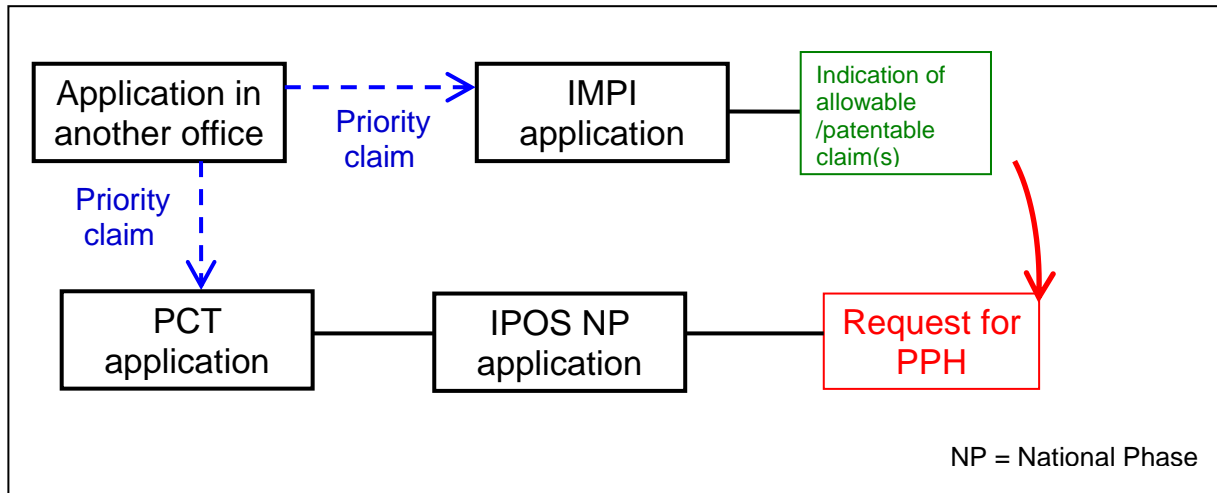

**Scenario (10):** The IPOS application (“IPOS NP application”) and the IMPI application (“IMPI NP application”) being relied upon for the PPH request, are national phase entries of the same PCT application

